



## features & benefits

*Here is a premier, heavy-duty panel kit for your displays. The Hero locks solidly together to give you a beefy wall to display your graphics and information. In either the Tabletop size or the Exhibit height, the Hero will save the day for your panel display needs.*

*Hero portable folding panels offer the convenience of folding panels with elegant, seamless panel construction. This system offers concealed hinges, lightweight durability and superb craftsmanship. Panels are constructed of an ultra light core material and covered on both sides with polyester fabric. Full height exhibits can be used separately as two tabletop units! The unique 2" radius curved ends lend a polished appearance.*

### Hero Kits

H01	H09
H02	H10
H02-2	H11
H03	H12-1
H04	H12-2
H05	H13
H06	H14
H07	H15-1
H08	H15-2

# Assembly Instructions

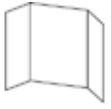

**HO1 Showcase**  
 Kit includes: Self contained 3 panel folding system. Fabric one side, flame-retardant ABS with haircell finish on reverse, Includes strap closure, handle and shoulder strap  
 Dimensions: 30"h x 40"w x 11"d Weight: 13 lbs.

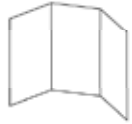

**HO2-1 6' Tabletop**  
 Kit includes: 1-3 Panel base  
 Packing options: 1-Cardboard Box, 25 lbs. 1-Carry Bag, 22 lbs. 1-Molded Case 37 lbs.  
 Dimensions: 47 1/2"h x 58"w x 17"d Weight: 180 lbs.

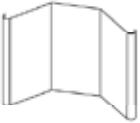

**HO2-2 6' Tabletop**  
 Kit includes: 1-3 Panel base, 2-Curve panels  
 Packing options: 1-Cardboard Box, 30 lbs. 1-Molded Case 42 lbs.  
 Dimensions: 47 1/2"h x 63"w x 18"d



**HO3 6' Tabletop**  
 Kit includes: 1-3 Panel base, 1-S. Header, 2-Lights  
 Packing options: 1-Cardboard Box, 34 lbs. 1-Molded Case 46 lbs.  
 Dimensions: 47 1/2"h x 58"w x 17"d



**HO4 6' Tabletop**  
 Kit includes: 1-3 Panel base, 2-Curve panels, 1-S. header, 2-Lights  
 Packing options: 1-Cardboard Box, 39 lbs. 1-Molded Case 51 lbs.  
 Dimensions: 47 1/2"h x 63"w x 18"d

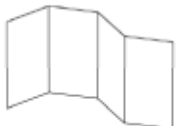

**HO5 8' Tabletop**  
 Kit includes: 1-4 Panel base,  
 Packing options: 1-Cardboard Box, 37 lbs. 1-Carry Bag, 34 lbs. 1-Molded Case 49 lbs.  
 Dimensions: 47 1/2"h x 83"w x 17"d



**HO6 8' Tabletop**  
 Kit includes: 1-4 Panel base, 1-S. header, 2-Lights  
 Packing options: 1-Cardboard Box, 46 lbs. 1-Molded Case 58 lbs.  
 Dimensions: 47 1/2"h x 83"w x 17"d



**HO7 8' Tabletop**  
 Kit includes: 1-4 Panel base, 2-Curve panels, 1-S. header, 2-Lights  
 Packing options: 1-Cardboard Box, 51 lbs. 1-Molded Case 63 lbs.  
 Dimensions: 47 1/2"h x 88"w x 18"d

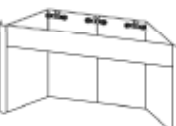

**HO8 8' Tabletop**  
 Kit includes: 1-4 Panel base, 2-Curve panels, 1-L. header, 3-Lights  
 Packing options: 1-Cardboard Box, 55 lbs. 1-Molded Case 67 lbs.  
 Dimensions: 47 1/2"h x 88"w x 18"d



**HO9 6' Exhibit**  
 Kit includes: 1-3 Panel base, 1- 3 Panel top, 4-Curve panels  
 Packing options: 1-Cardboard Box, 48 lbs. 1-Molded Case 60 lbs.  
 Dimensions: 94 3/4"h x 63"w x 18"d



**H10 8' Exhibit**  
 Kit includes: 1-4 Panel base, 1- 4 Panel top, 4-Curve panels, 1-L. header, 3-Lights  
 Packing options: 2-Cardboard Box, 96 lbs. 2-Molded Case 120 lbs.  
 Dimensions: 94 3/4"h x 88"w x 18"d

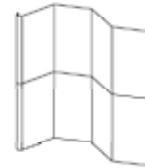

**H11 8' Exhibit**  
 Kit includes: 1-4 Panel base, 1- 4 Panel top, 4-Curve panels  
 Packing options: 2-Cardboard Box, 83 lbs. 2-Molded Case 107 lbs.  
 Dimensions: 94 3/4"h x 88"w x 18"d



**H12-1 10' Exhibit**  
 Kit includes: 1-5 Panel base, 1- 5 Panel top, 4-Curve panels, 1-L. header, 3-Lights  
 Packing options: 2-Cardboard Box, 108 lbs. 2-Molded Case 132 lbs.  
 Dimensions: 94 3/4"h x 110"w x 18"d



**H12-2 10' Exhibit**  
 Kit includes: 1-5 Panel base, 1- 5 Panel top, 4-Curve panels, 1-L. header, 3-Lights, 1-Counter  
 Packing options: 3-Cardboard Box, 163 lbs. 3-Molded Case 199 lbs.  
 Dimensions: 94 3/4"h x 110"w x 18"d

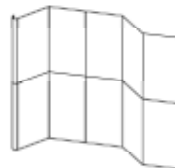

**H13 10' Exhibit**  
 Kit includes: 1-5 Panel base, 1- 5 Panel top, 4-Curve panels  
 Packing options: 2-Cardboard Box, 95 lbs. 2-Molded Case 119 lbs.  
 Dimensions: 94 3/4"h x 110"w x 18"d

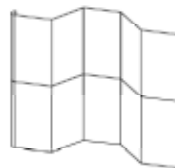

**H14 Island Exhibit**  
 Kit includes: 1-5 Panel base, 1- 5 Panel top, 4-Curve panels  
 Packing options: 2-Cardboard Box, 95 lbs. 2-Molded Case 119 lbs.  
 Dimensions: 94 3/4"h x 110"w x 18"d

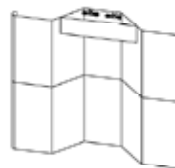

**H15-1 10' Exhibit**  
 Kit includes: 1-5 Panel base, 1- 5 Panel top, 4-Curve panels, 1-S. header, 2-Lights  
 Packing options: 2-Cardboard Box, 104 lbs. 2-Molded Case 128 lbs.  
 Dimensions: 94 3/4"h x 110"w x 18"d

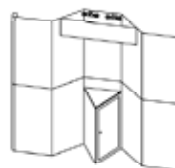

**H15-2 10' Exhibit**  
 Kit includes: 1-5 Panel base, 1- 5 Panel top, 4-Curve panels, 1-S. header, 2-Lights, 1-Counter  
 Packing options: 3-Cardboard Box, 143 lbs. 3-Molded Case 186 lbs.  
 Dimensions: 94 3/4"h x 110"w x 18"d

# Assembly Instructions

## Hero Header Sizes

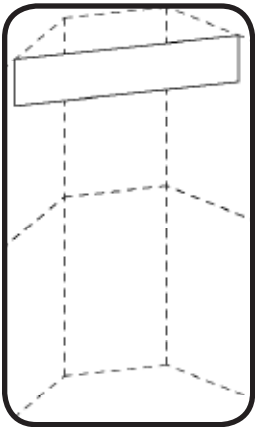

### S. header

Dimen: 45" x 11 13/16"  
Plex cut size: 11 23/32"x 44 7/8"  
Graphic Substrate: Milk Plex  
Weight: 4 lbs.

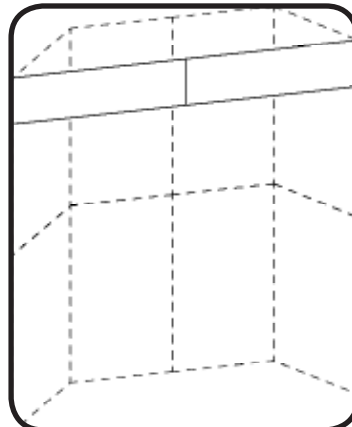

### L. header

Dimen: 75" x 11 13/16"  
Plex cut size: 11 23/32"x 37 15/32"  
Graphic Substrate: Milk Plex  
Weight: 6 lbs.

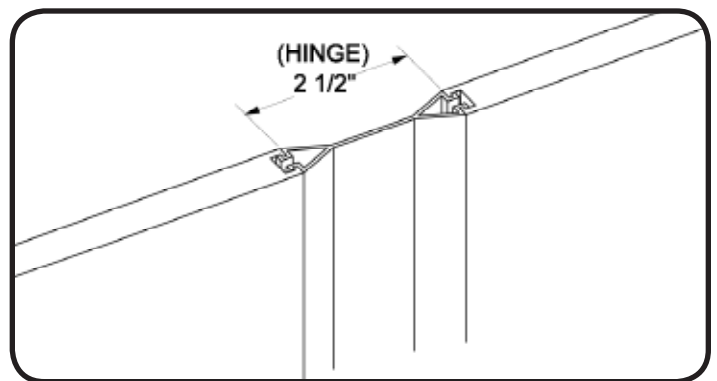
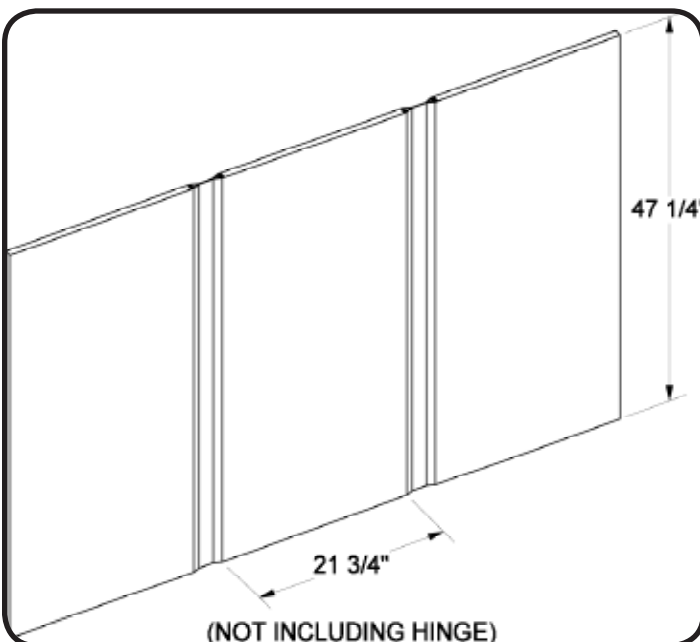
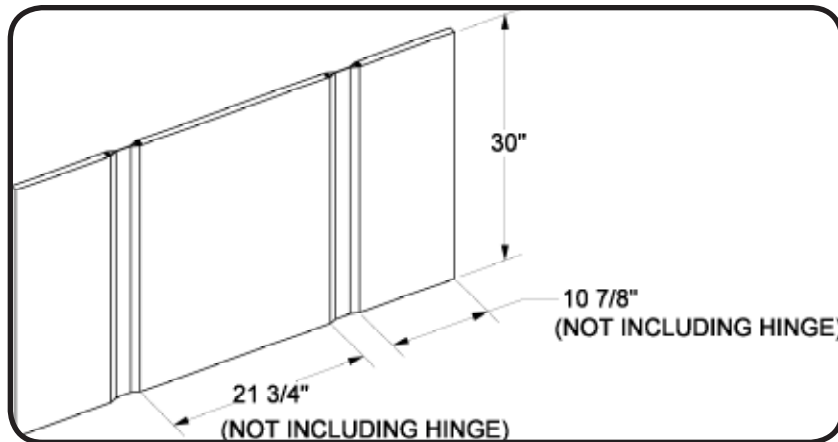

## Hero Panel Sizes

# Set-up Instructions

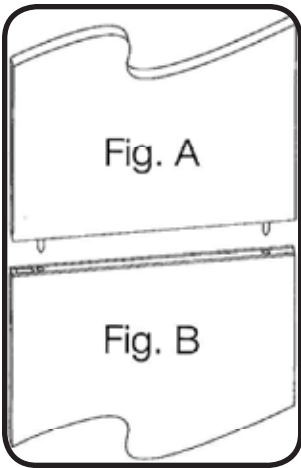

## 1 Assembly

There are two sets of panels in a full-height unit. A top section and a base section. The top section (figure A) has location pins along the base of the panels. The bottom section (figure B) has rubber feet along the bottom.

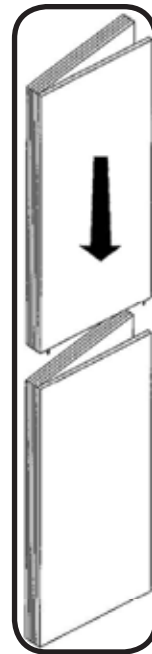

## 2 Stacking

There are two sets of panels in a full-height unit, a top section and a base section. Next, place base section on the floor. The top section (Fig. A) has pins facing downward, location pins along the top of the bottom base of the panels. The section and align pins bottom section (Fig. B) with pin holes on has rubber feet along bottom section. the bottom.

## 4 Add Optional Curved Panels

End flat panels have three connectors along the edge which attach curves. Attached curves by sliding cut-out sections of curve edge, located at dot position, over and down on panel connectors as shown.

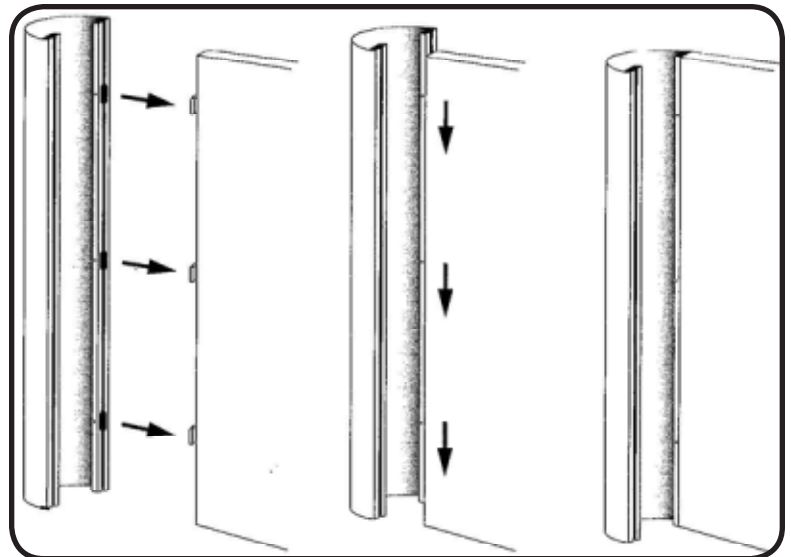
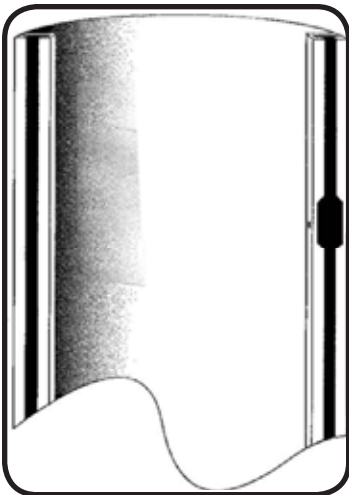

# Assembly Instructions

## 3 Unfold Display

Unfold the display to the desired configuration by holding the bottom section and swinging outward in the direction of the arrows.

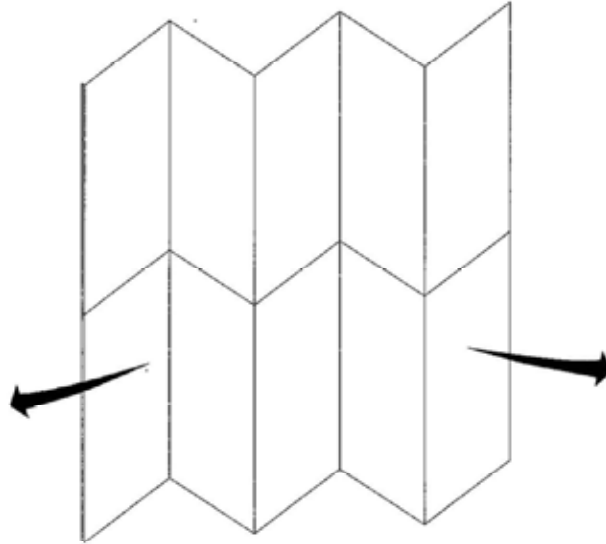

## 5 Add Accessories

Center the header on the display as desired and hang with attached header hooks.

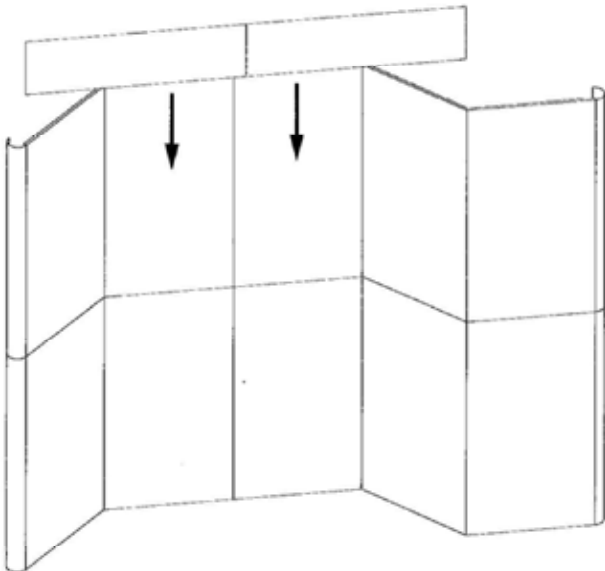

## 6 Packing

Careful repacking of your exhibit will lead to years of use.

Curves  
Lights  
Cardboard Panels

